

RSHPM-Series

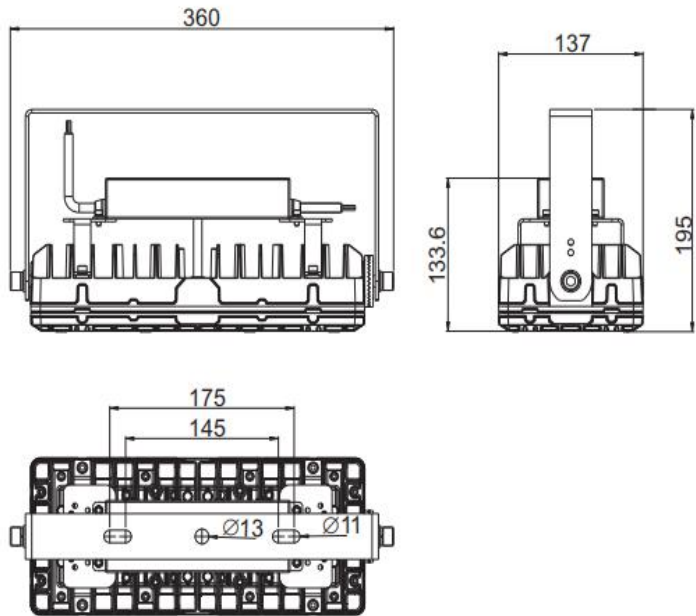

Led Modular Flood Light

RSHPM-100W-U-1



Parameters

Electrical

Model No.	RSHPM-100W-U-1
Power	100W
Input Voltage	100-305VAC, 50/60Hz
Input Current	0.909A/110VAC, 0.454A/220VAC 0.361A/277VAC
Power Factor	>0.95
Power efficiency	>88%

Optical

Lumens	Lumen tolerance +/- 5% 13000lm
Lumen Efficiency	130lm/W
CRI	Ra>70
CCT	2700K/3000K/3500K/4000K 5000K/5700K/6500K
Beam Angles	15°, 40°, 60°, 90°, 30x70°

Physical

IP&IK Rating	IP65 & IK08
Life Span	50000 hours, @25°C
Product Size	L360×W137×H194mm
N.W./Pcs	4.6kg
G.W./Pcs	5.1kg
Carton Size	395*245*195mm
Pcs/CTN	1pcs/ctn
Heat-sink Material	Aluminum
Lens Material	PC
LED Driver	Meanwell Driver
LED Chip	Lumileds Luxeon 3030 2D

Angle:15°

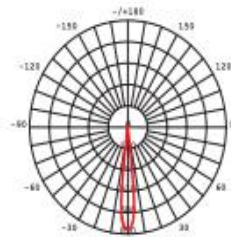

Angle:40°

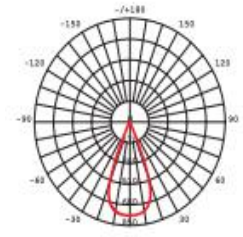

Angle:60°

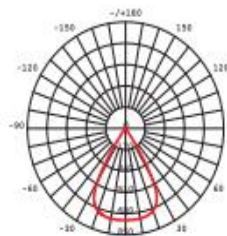

Angle:90°

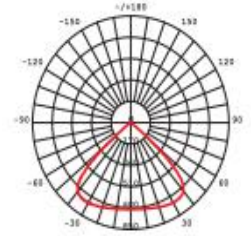

Angle:30X70°

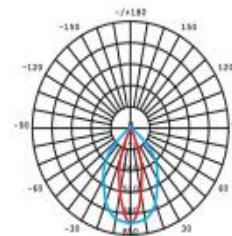

RSHPM-200W-U-1

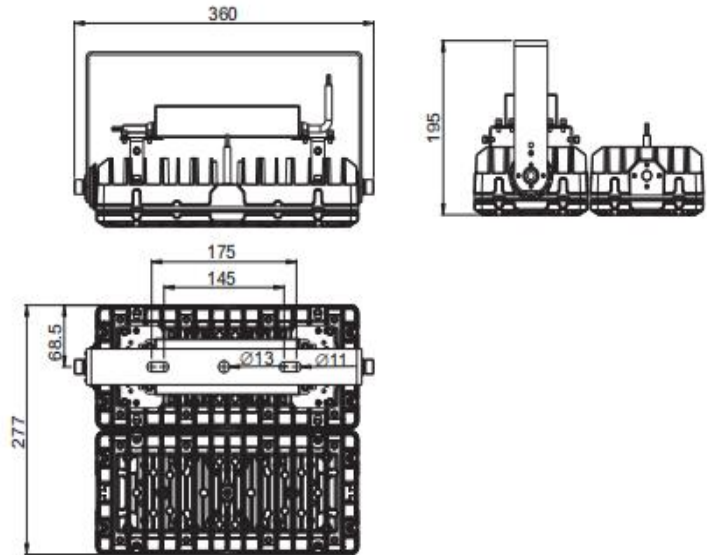

Parameters

Electrical

Model No.	RSHPM-200W-U-1
Power	200W
Input Voltage	100-305VAC, 50/60Hz
Input Current	1.818A/110VAC, 0.909A/220VAC
	0.722A/277VAC
Power Factor	>0.95
Power efficiency	>88%

Optical

Lumens	Lumen tolerance +/- 5%
	26000lm
Lumen Efficiency	130lm/W
CRI	Ra>70
CCT	2700K/3000K/3500K/4000K
	5000K/5700K/6500K
Beam Angles	15°,40°,60°, 90°,30x70°

Physical

IP&IK Rating	IP65 & IK08
Life Span	50000 hours, @25°C
Product Size	L360×W277×H194mm
N.W./Pcs	7.7 kg
G.W./Pcs	8.8 kg
Carton Size	385*355*195mm
Pcs/CTN	1 pcs/ctn
Heat-sink Material	Aluminum
Lens Material	PC
LED Driver	Meanwell Driver
LED Chip	Lumileds Luuxon 3030 2D

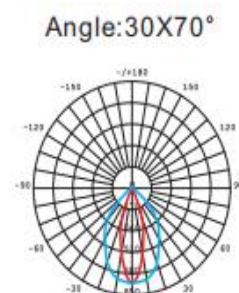
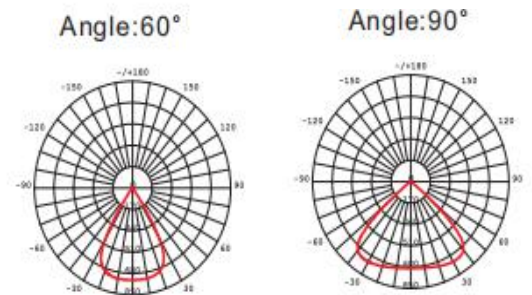
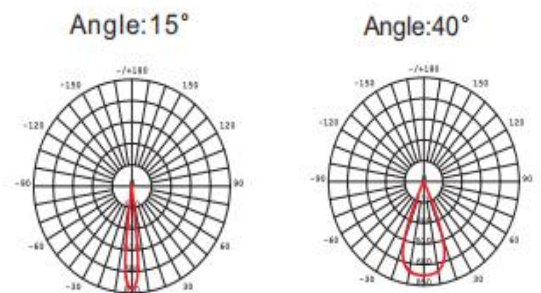

RSHPM-300W-U-2

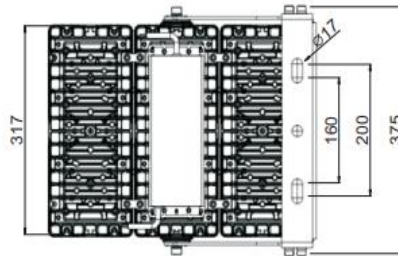
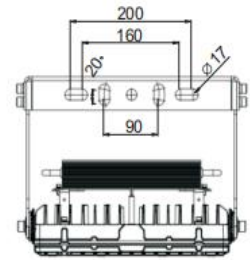
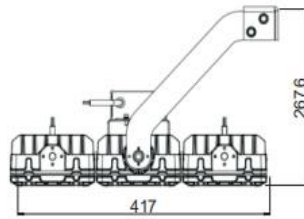

Parameters

Electrical

Model No.	RSHPM-300W-U-2
Power	300W
Input Voltage	100-305VAC, 50/60Hz
Input Current	2.727A/110VAC, 1.363A/220VAC 1.083/277VAC
Power Factor	>0.95
Power efficiency	>88%

Optical

Lumens	Lumen tolerance +/- 5% 39000lm
Lumen Efficiency	130lm/W
CRI	Ra>70
CCT	2700K/3000K/3500K/4000K 5000K/5700K/6500K
Beam Angles	15°,40°,60°, 90°,30x70°

Physical

IP&IK Rating	IP65 & IK08
Life Span	50000 hours, @25°C
Product Size	L417×W375×H268mm
N.W./Pcs	11.6 kg
G.W./Pcs	13.1 kg
Carton Size	600*445*220mm
Pcs/CTN	1 pcs/ctn
Heat-sink Material	Aluminum
Lens Material	PC
LED Driver	Meanwell Driver
LED Chip	Lumileds Luxeon 3030 2D

Angle:15°

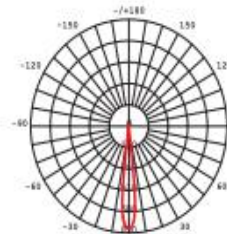

Angle:40°

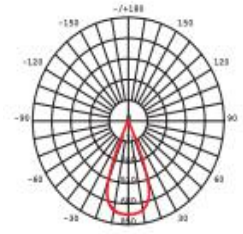

Angle:60°

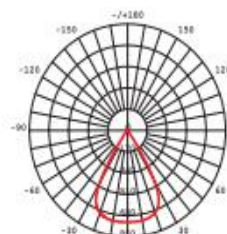

Angle:90°

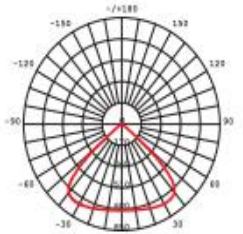

Angle:30X70°

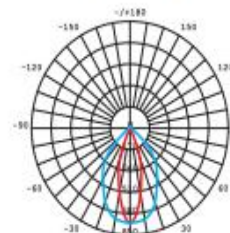

RSHPM-400W-U-2

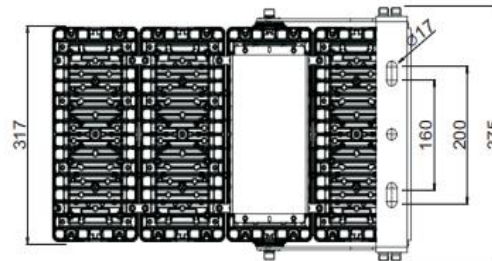
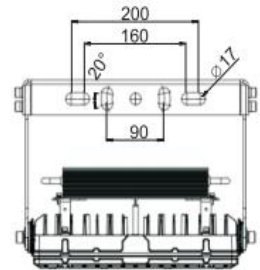
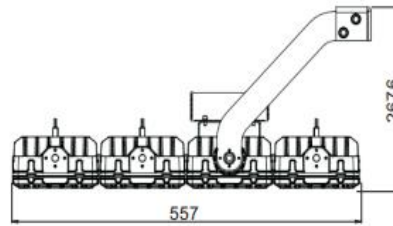

Parameters

Electrical

Model No.	RSHPM-400W-U-2
Power	400W
Input Voltage	100-305VAC, 50/60Hz
Input Current	3.636A/110VAC, 1.818A/220VAC 1.444A/277VAC
Power Factor	>0.95
Power efficiency	>88%

Optical

Lumens	Lumen tolerance +/- 5% 52000lm
Lumen Efficiency	130lm/W
CRI	Ra>70
CCT	2700K/3000K/3500K/4000K 5000K/5700K/6500K
Beam Angles	15°,40°,60°, 90°,30x70°

Physical

IP&IK Rating	IP65 & IK08
Life Span	50000 hours, @25°C
Product Size	L557×W375×H268mm
N.W./Pcs	15.1 kg
G.W./Pcs	16.6 kg
Carton Size	610*390*220mm
Pcs/CTN	1pcs/ctn
Heat-sink Material	Aluminum
Lens Material	PC
LED Driver	Meanwell Driver
LED Chip	Lumileds Luuxon 3030 2D

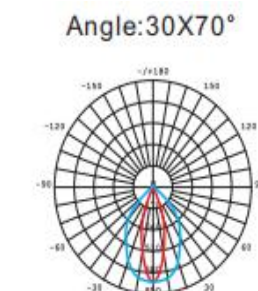
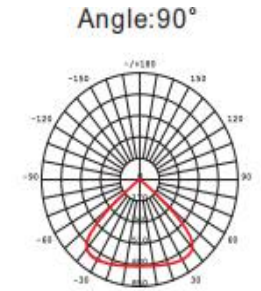
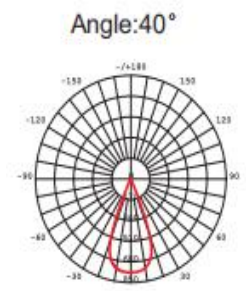
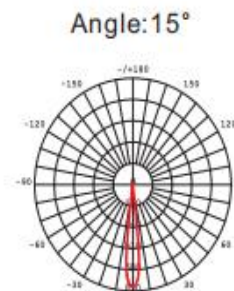

RSHPM-500W-U-2

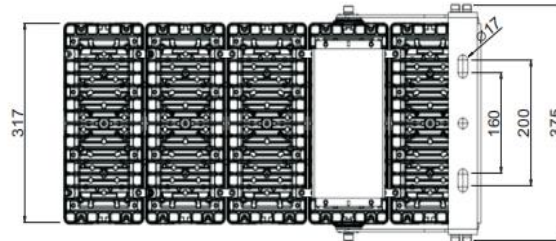
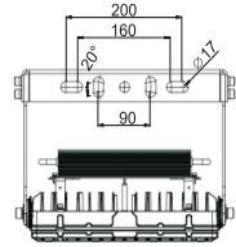
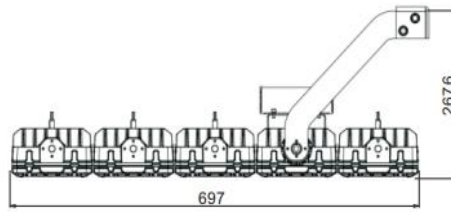

Parameters

Electrical

Model No.	RSHPM-500W-U-2
Power	500W
Input Voltage	100-305VAC, 50/60Hz
Input Current	4.545A/110VAC, 2.272A/220VAC 1.805A/277VAC
Power Factor	>0.95
Power efficiency	>88%

Optical

Lumens	Lumen tolerance +/- 5% 65000lm
Lumen Efficiency	130lm/W
CRI	Ra>70
CCT	2700K/3000K/3500K/4000K/4500I 5000K/5700K/6500K
Beam Angles	15°, 40°, 60°, 90°, 30x70°

Physical

IP&IK Rating	IP65 & IK08
Life Span	50000 hours, @25°C
Product Size	L697×W375×H268mm
N.W./Pcs	17.3 kg
G.W./Pcs	19.1 kg
Carton Size	750*390*220mm
Pcs/CTN	1pcs/ctn
Heat-sink Material	Aluminum
Lens Material	PC
LED Driver	Meanwell Driver
LED Chip	Lumileds Luexon 3030 2D

Angle:15°

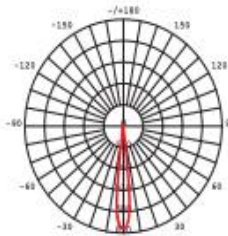

Angle:40°

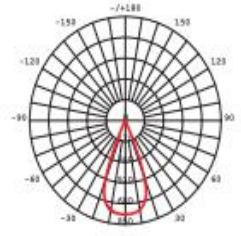

Angle:60°

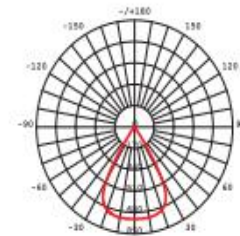

Angle:90°

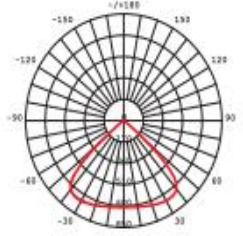

Angle:30X70°

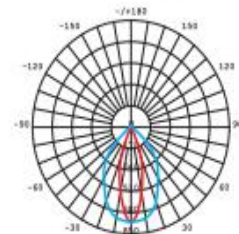

RSHPM-600W-U-2

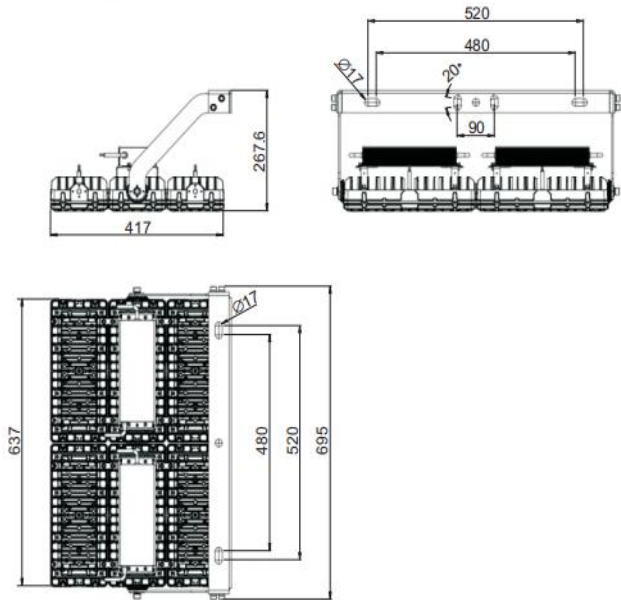

Parameters

Electrical

Model No.	RSHPM-600W-U-2
Power	600W
Input Voltage	100-305VAC, 50/60Hz
Input Current	5.454A/110VAC, 2.727A/220VAC 2.166A/277VAC
Power Factor	>0.95
Power efficiency	>88%

Optical

Lumens	Lumen tolerance +/- 5% 78000lm
Lumen Efficiency	130lm/W
CRI	Ra>70
CCT	2700K/3000K/3500K/4000K/4500K 5000K/5700K/6500K
Beam Angles	15°,40°,60°, 90°,30x70°

Physical

IP&IK Rating	IP65 & IK08
Life Span	50000 hours, @25°C
Product Size	L471×W695×H268mm
N.W./Pcs	22.1 kg
G.W./Pcs	24.6 kg
Carton Size	765*600*220mm
Pcs/CTN	1pcs/ctn
Heat-sink Material	Aluminum
Lens Material	PC
LED Driver	Meanwell Driver
LED Chip	Lumileds Luuxon 3030 2D

Angle:15°

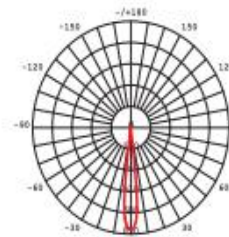

Angle:40°

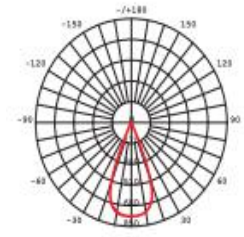

Angle:60°

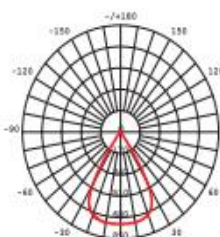

Angle:90°

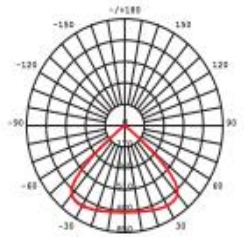

Angle:30X70°

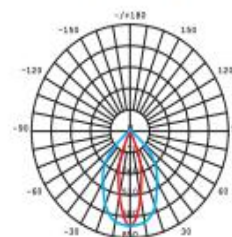

RSHPM-800W-U-2

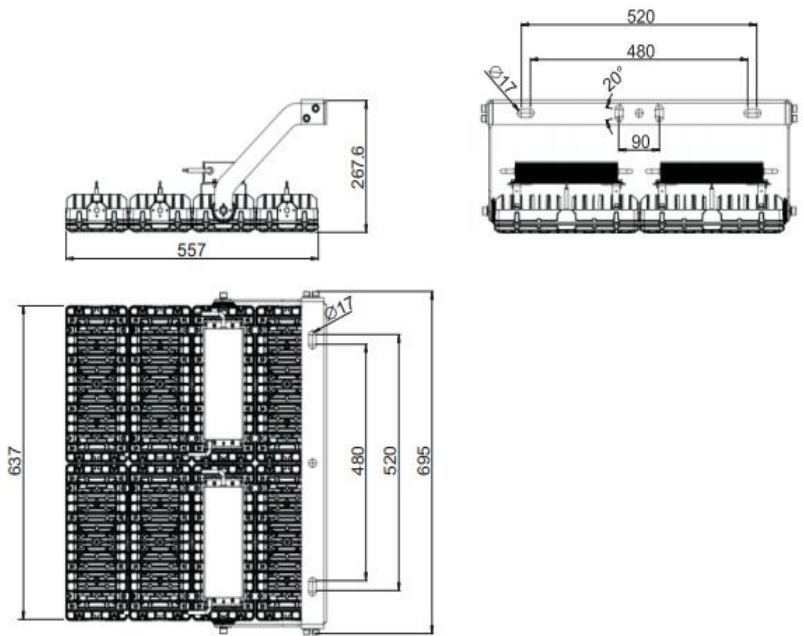

Parameters

Electrical

Model No.	RSHPM-800W-U-2
Power	800W
Input Voltage	100-305VAC, 50/60Hz
Input Current	7.272A/110VAC, 3.636A/220VAC 2.888A/277VAC
Power Factor	>0.95
Power efficiency	>88%

Optical

Lumens	Lumen tolerance +/- 5% 104000lm
Lumen Efficiency	130lm/W
CRI	Ra>70
CCT	2700K/3000K/3500K/4000K/4500K 5000K/5700K/6500K
Beam Angles	15°,40°,60°, 90°,30x70°

Physical

IP&IK Rating	IP65 & IK08
Life Span	50000 hours, @25°C
Product Size	L577×W695×H268mm
N.W./Pcs	29.1 kg
G.W./Pcs	31.6 kg
Carton Size	735*637*240mm
Pcs/CTN	1pcs/ctn
Heat-sink Material	Aluminum
Lens Material	PC
LED Driver	Meanwell Driver
LED Chip	Lumileds Luuxon 3030 2D

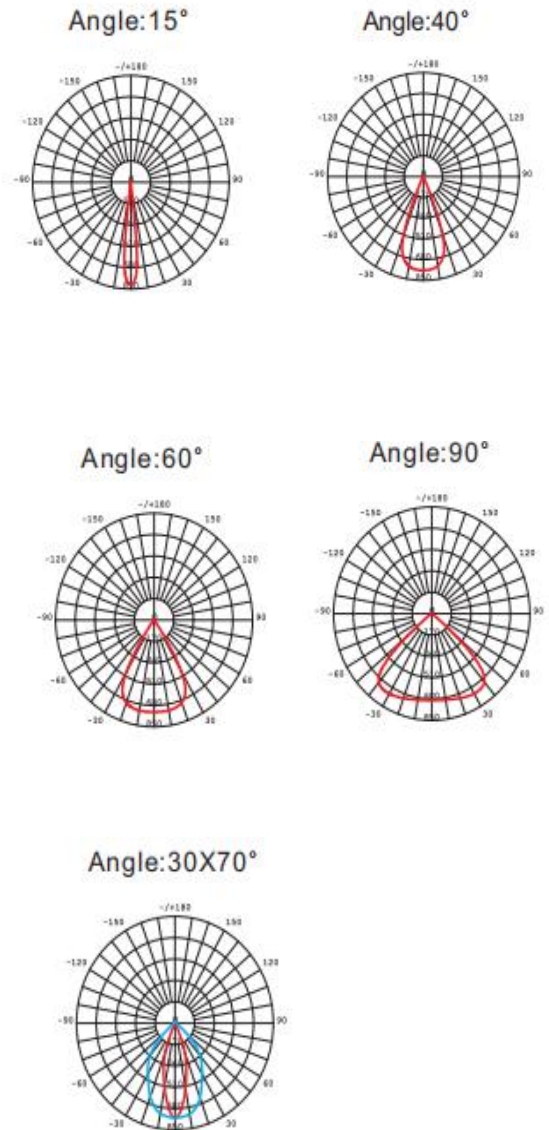

RSHPM-1000W-U-2

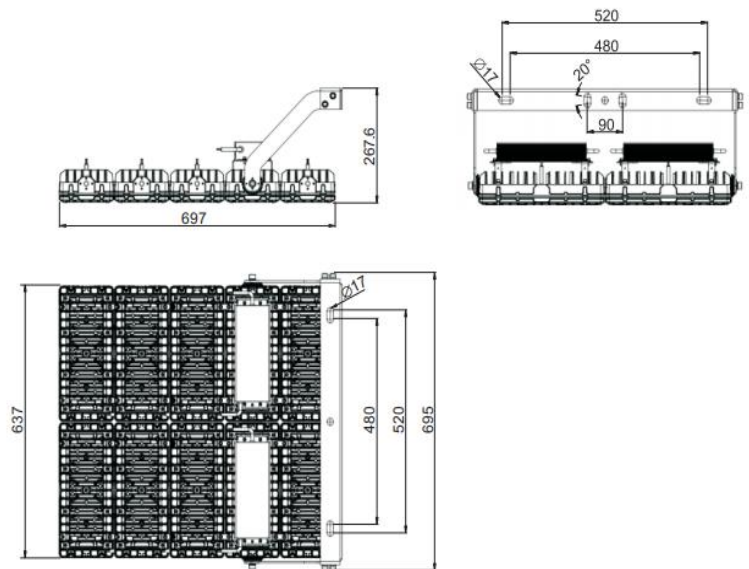

Parameters

Electrical

Model No.	RSHPM-1000W-U-2
Power	1000W
Input Voltage	100-305VAC, 50/60Hz
Input Current	9.090A/110VAC, 4.545A/220VAC 3.610A/277VAC
Power Factor	>0.95
Power efficiency	>88%

Optical

Lumens	Lumen tolerance +/- 5% 130000lm
Lumen Efficiency	130lm/W
CRI	Ra>70
CCT	2700K/3000K/3500K/4000K 5000K/5700K/6500K
Beam Angles	15°, 40°, 60°, 90°, 30x70°

Physical

IP&IK Rating	IP65 & IK08
Life Span	50000 hours, @25°C
Product Size	L697×W695×H268mm
N.W./Pcs	35.0kg
G.W./Pcs	38.2kg
Carton Size	735x755x240mm
Pcs/CTN	1pcs/ctn
Heat-sink Material	Aluminum
Lens Material	PC
LED Driver	Meanwell Driver
LED Chip	Lumileds Luxeon 3030 2D

Angle:15°

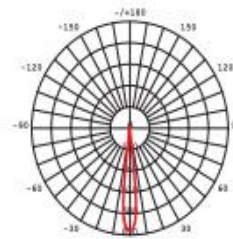

Angle:40°

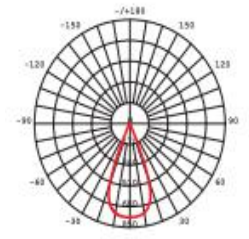

Angle:60°

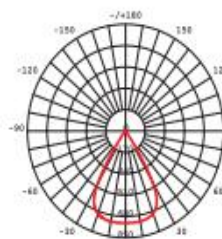

Angle:90°

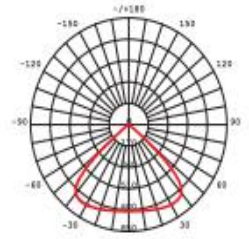

Angle:30X70°

